

Acoustic damping

Accessories • 2004-01-01

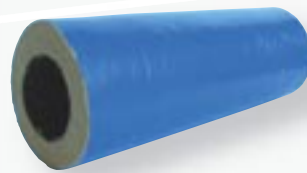

- Complete range
- Large flexibility
- Custom-made solutions



dB-pipe

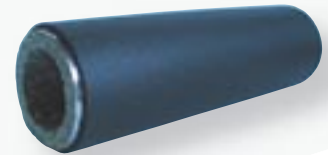

dB-S-pipe

Sound reducing wall pipes

We have several different sound reducing solutions for our wall vents.

We also have the possibility to make special solutions for a specific project, for further information please contact Fresh AB.



Baffle



Z-dB channel

Specification

Product	Description	Art no bulk
dB-S-pipe Ø81/124 x 400	Sound reduced wall pipe Ø81/124 x 400	668003
dB-pipe Ø81/140 x 400	Sound reduced wall pipe Ø81/140 x 400	806004
dB-pipe Ø98/140 x 400	Sound reduced wall pipe Ø98/140 x 400	855004
Baffle 180 x 83 mm	Baffle for mounting in dB-pipe, gives extra sound reduction	008200
Baffle 180 x 105 mm	Baffle for mounting in dB-pipe, gives extra sound reduction	008199
Sound reducing mat 100 x 300	Sound reducing mat for mounting in plastic wall pipe Ø98/102	660103
dB-cowl	Sound reducing cover for outdoor mounting	100026
Z-dB channel*	Sound reducing channel, made of galvaniz !ed steel sheet	

* not a stock-item

Acoustic damping

Accessories • 2004-01-01

Sound reducing wall pipes

The dB-pipe replaces the standard pipe in plastic and has a sound reduction of up to $D_{n,e,w}$ 54 dB.

Measurement dB-pipe

Product	D1	D2	L
dB-S-pipe Ø81/124 x 400	81	124	400
dB-pipe Ø81/140 x 400	81	140	400
dB-pipe Ø98/140 x 400	95	140	400

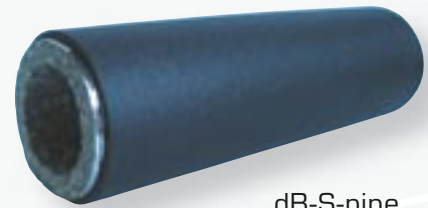
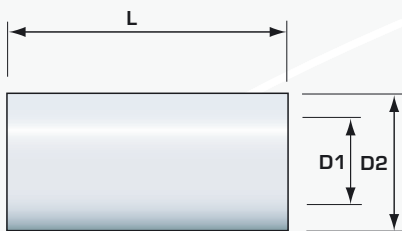

dB-S-pipe

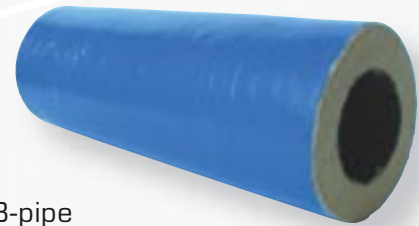

dB-pipe

Sound reducing baffle

10 mm thick cross-wall, made of bindex-treated insulation material. The baffle is mounted in the dB-pipe and increases the acoustic damping up to 3 dB compared to the standard version.



Sound reducing mat

8 mm thick sound absorbing mat which is mounted inside the standard pipe in plastic, Ø98/102 mm.



dB-cowl

The cowl is mounted over the existing outdoor grille. Increases the acoustic damping with approx. 2 dB.

Dimension: #180 mm
Protruding top: 60mm,
bottom: 110 mm

Material: Galvanized sheet steel (varnished)

Colour: Terracotta (reddishbrown),
for other colours please contact
Fresh AB.



Acoustic damping

Accessories • 2004-01-01

Z-dB channel

Sound absorbing channel made of perforated galvanized steel sheet. The channel is placed in the wall insulation sheet (it uses this sheet as a sound absorbing unit).

The Z-dB channel is custom-made (not a stock-item). Sound reduction: up to 62 D_{n,e,w}.

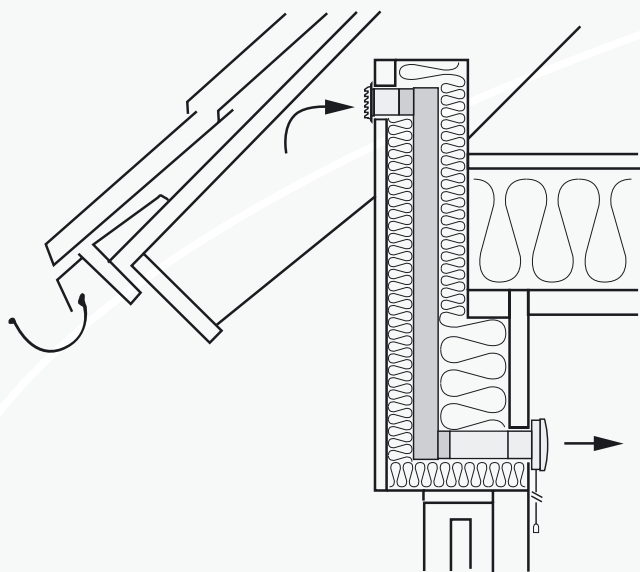

Sound reducing data with Fresh 80

The diagram shows sound reduction with fully open vent and a reference area of 10 m².

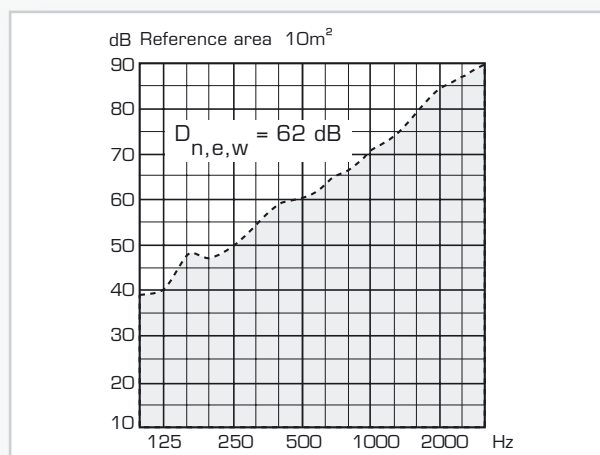

Capacity with Fresh 80

Dotted line = pollen filter

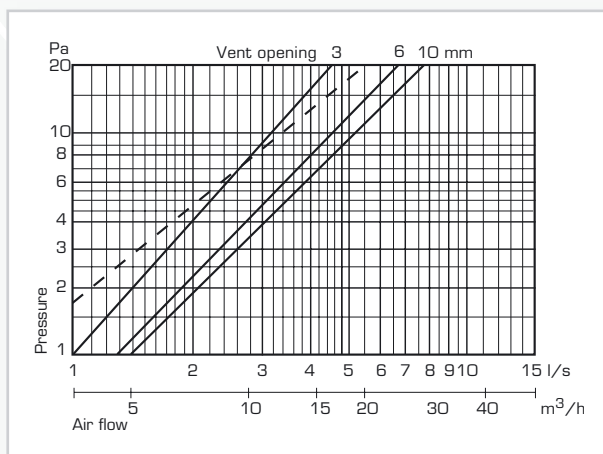

Capacity with Fresh 100

Dotted line = pollen filter

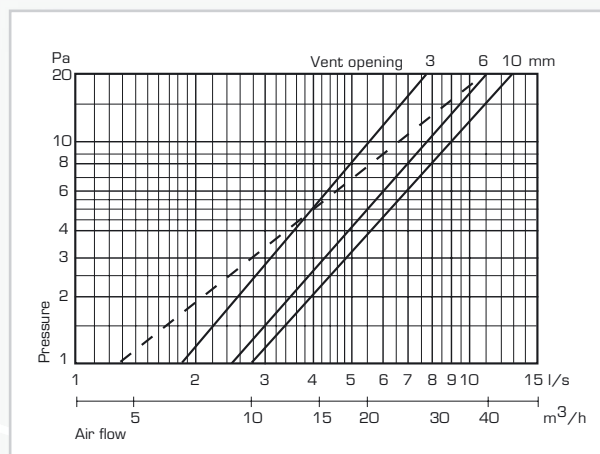

All rights reserved



FRESH AB
Box 7
SE-360 32 GEMLA
www.fresh.se

Telephone +46 (0)470 70 77 00
Fax +46 (0)470 70 77 39
E-mail information@fresh.se

Copyright © Fresh AB 2004 - All rights reserved